





	Radna širina	Gnječilica	Transportni položaj
AM 203 S	2,00 m	-	90° prema gore
AM 243 S	2,40 m	-	90° prema gore
AM 283 S	2,80 m	-	90° prema gore
AM 323 S	3,20 m	-	90° prema gore
AM 243 CV	2,40 m	V-čelični prsti	90° prema gore



- Bočno uporište
- Veliki kut njihanja
- Rasteretne opruge
- Greben kose varen u jednom komadu
- Pogon preko satelitskih zupčanika
- Doživotno podmazan greben kose
- Brza izmjena noževa

## Kosilice sa bočnim osloncem

- Novokonstruiran greben kosilice 
- Osiguranje diskova SafeCut 
- Novokonstruirano kopčanje
- Radnog zahvata (širine) od 2,05 m do 3,61 m



**NEU**

	Radna širina	Transportni položaj
ActiveMow R 200	2,05 m	100° prema gore
ActiveMow R 240	2,44 m	100° prema gore
ActiveMow R 280	2,83 m	100° prema gore
ActiveMow R 320	3,22 m	100° prema gore
ActiveMow R 360	3,61 m	100° prema gore

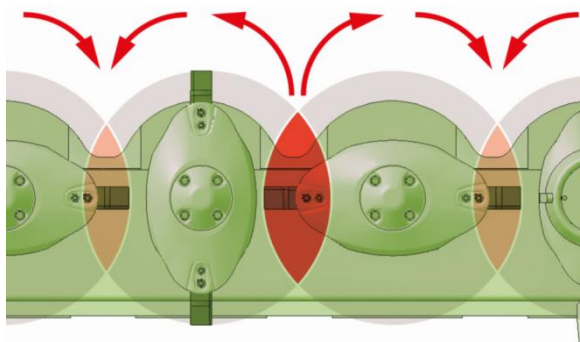

Beispielbild EasyCut

**ActiveMow**

**MEHANIZACIJA Miler®**

# **KRONE** Bočne Kosilice - EasyCut

	Radna širina	Gnječilica	Transportni položaj
EC R 280	2,73 m	-	110° prema gore
EC R 320	3,16 m	-	110° prema gore
EC R 360	3,60 m	-	124° prema gore
EC 400	4,00 m		90° unazad
EC R 280 CV	2,73 m	V-čelični prsti	124° prema gore
EC R 280 CR <b>NEU</b>	2,73 m	Valjci za gnječenje	124° prema gore
EC R 320 CV	3,16 m	V-čelični prsti	124° prema gore
EC R 320 CR <b>NEU</b>	3,16 m	Valjci za gnječenje	124° prema gore



- Osiguranje diskova SafeCut 
- Sa čeličnim prstima - i valjcima za gnječenje

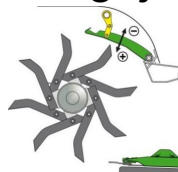

**MEHANIZACIJA** *Miler*<sup>®</sup>

	Radna širina	Gnječilica	
EC F 280 M	2,73 m	-	
EC F 280	2,71 m	-	Bubanj za sakupljanje u zbojeve
EC F 320 M	3,16 m	-	
EC F 320	3,14 m	-	Bubanj za sakupljanje u zbojeve
EC F 360 M	3,60 m	-	
EC F 360	3,57 m	-	Bubanj za sakupljanje u zbojeve
EC 28 CV	2,71 m	Čelični prsti	
EC F 320 CV	3,16 m	V-čelični prsti	
EC F 320 CV <b>NEU</b>	3,16 m	V-čelični prsti	Novo kopčanje
EC F 320 CR <b>NEU</b>	3,16 m	Valjci za gnječenje	
EC F 360 CV	3,60 m	V-čelični prsti	
EC F 360 CR <b>NEU</b>	3,60 m	Valjci za gnječenje	

# KRONE Čeone kosilice - EasyCut

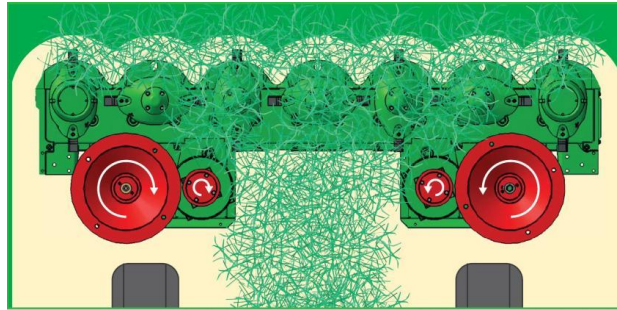

**SafeCut  
INSIDE**

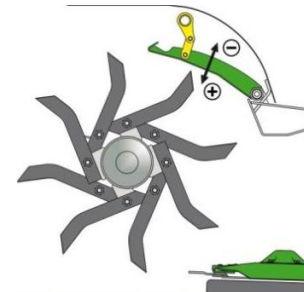
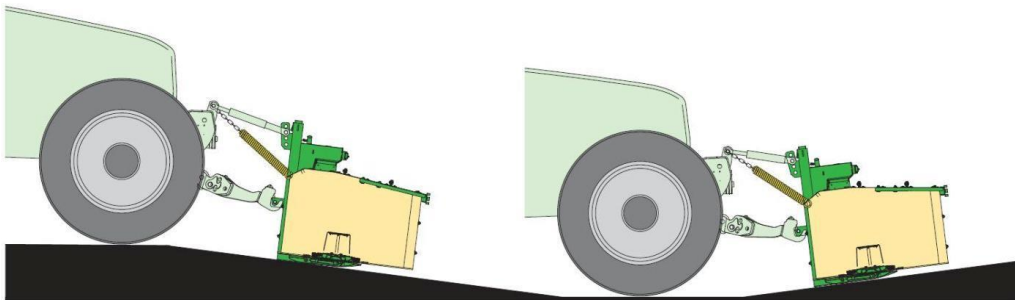

**MEHANIZACIJA Miler®**

# **KRONE** Kombinacije kosilica - EasyCut

	Radna širina	Gnječilica	Transportni trak
EC B 750	7,46 m	-	
EC B 890	8,60 - 8,90 m	-	
EC B 970	9,40 - 9,70 m	-	
EC B 870 CV	8,70 m	V-čelični prsti	
EC B 870 CV Collect	8,70 m	V-čelični prsti	X
EC B 870 CR <b>NEU</b>	8,70 m	Valjci za gnječenje	
EC B 870 CR Collect <b>NEU</b>	8,70 m	Valjci za gnječenje	X
EC B 1000 CV	9,30 - 10,10 m	Valjci za gnječenje	
EC B 1000 CV Collect	9,30 - 10,10 m	V-čelični prsti	X
EC B 1000 CR <b>NEU</b>	9,30 - 10,10 m	Valjci za gnječenje	
EC B 1000 CR Collect <b>NEU</b>	9,30 - 10,10 m	Valjci za gnječenje	X



# KRONE Kombinacije kosilica - EasyCut

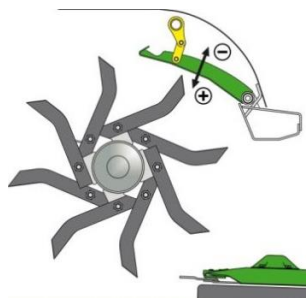
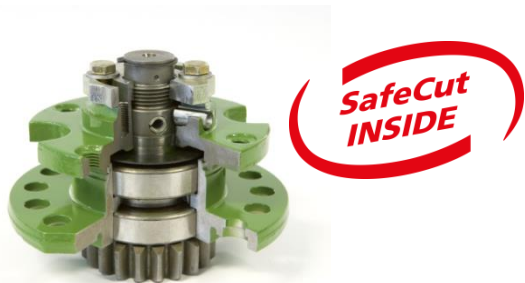

	Radna širina	Greben kosilice	Rudo	Gnječilica	Transportna traka
EC 2801 CV	2,73 m		Bočno	V-čelični prsti	-
EC 2800 CRi	2,71 m		Bočno	Valjci za gnječenje	-
EC 3200	3,16 m		Bočno	-	-
EC 3201 CV	3,16 m		Bočno	V-čelični prsti	Opcija
EC 3200 CRi	3,14 m		Bočno	Valjci za gnječenje	Opcija
EC 3210 CV	3,16 m		Centralno	V-čelični prsti	Opcija
EC 3210 CRi	3,14 m		Centralno	Valjci za gnječenje	-
EC 3600 CV	3,60 m		Bočno	V-čelični prsti	Opcija
EC 4013 CV	4,00 m		Centralno	Čelični prsti	-
EC 6210 CV	6,20 m		Centralno	Čelični prsti	-



# **KRONE** Vučene kosilice





## BiG M 420

## BiG M 500

MAN R6-Motor sa 311kW/423 PS i SCR

MAN R6-Motor sa 382kW/510 PS i SCR

Radna širina 9,0 m sa CRi valjkom za gnječenje

Radna širina 9,7 m sa CV čeličnim prstima

Radna širina 13,2 m sa CV – čeličnim prstima

Izuzetna brzina: 20 km/h na polju i 40 km/h na cesti

# KRONE BiG M



SafeCut  
INSIDE



MEHANIZACIJA Miler®

Model	Radna širina	Broj rotora	Broj ruku
KW 4.62/4	4,60 m	4	6
KW 5.52/4x7	5,50 m	4	7
KW 6.02/6	6,00 m	6	6
KW 6.72/6	6,70 m	6	6
KW 7.82/6x7	7,80 m	6	7
KW 7.92/8	7,90 m	8	5
KW 8.82/8	8,80 m	8	6
KW 10.02 <b>NEU</b>	10,00 m	10	5
KW 11.22	10,95 m	10	6



# KRONE Rotorski okretači KW

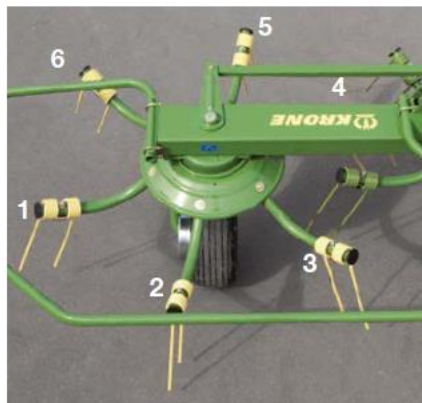
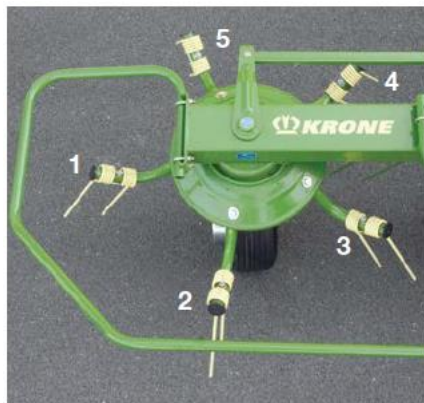
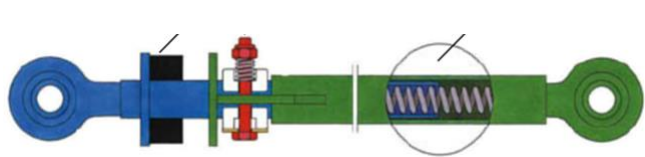

# **KRONE** Vučeni - rotorski okretač KW

Model	Radna širina	Broj rotora	Broj ruku
KW 13.02/12 T	13,10 m	12	6
KW 15.02/14 T	15,30 m	14	6
KWT 7.82/6x7	7,80 m	6	7
KWT 8.82/8	8,80 m	8	6
KWT 10.02/10 <b>NEU</b>	10,00 m	10	5
KWT 11.22/10	10,95 m	10	6
KWT 1600	15,30 m	14	6
KWT 2000	19,60 m	18	6



**MEHANIZACIJA** *Miler*<sup>®</sup>



# KRONE Vučeni – rotorski okretač KW



Model	Radna širina	Broj rotora	Ruke za sakupljanje
SW 35	3,50 m	1	10
SW 38	3,80 m	1	10
SW 42	4,20 m	1	13
SW 46 / 46 T	4,60 m	1	13
SW 710/26 T	6,20 m	2	2 x 13
SW 907	8,00 m	2	2 x 15
SW 1010	9,70 m	3	1 x 10 / 2 x 13





**Lift  
INSIDE**



Model	Radna širina		Promjer rotora	Broj ruku za grabljanje
	Jednostruki zboj	Dvostruki zboj		
Swadro TS 620	6,20 m		2,96 m	10/13
Swadro TS 620 <i>(Twin)</i>	6,20 m	6,90 m		
Swadro TS 680	6,80 m		3,30 m	13
Swadro TS 680 <i>(Twin)</i>	6,80 m	7,60 m		
Swadro TS 740	7,40 m		3,60 m	13
Swadro TS 740 <i>(Twin)</i>	7,40 m	8,20 m		



Model	Radna širina	Broj rotora	Broj ruku za grabljanje
Swadro TC 680	6,80 m	2	2 x 10
Swadro TC 760	6,80 m - 7,60 m	2	2 x 13
Swadro TC 760 <i>plus</i>	6,80 m - 7,60 m	2	2 x 13
Swadro TC 880	7,60 m - 8,80 m	2	2 x 13
Swadro TC 880 <i>plus</i>	7,60 m - 8,80 m	2	2 x 13
Swadro 1000	8,80 m - 10,00 m	2	2 x 15
Swadro 1400	11,00 m - 13,50 m	4	4 x 13
Swadro 1400 <i>plus</i>	11,00 m - 13,50 m	4	4 x 13
Swadro 2000	11,00 m - 19,50 m	6	6 x 13

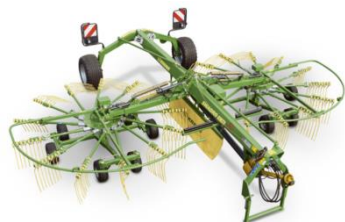

# KRONE Sakupljači



7



MEHANIZACIJA Miler®

Model	Promjer bala	Uređaj za sakupljanje	
Bellima F 125	1,20 m	1400 mm	Potiskivači
Bellima F 130	1,20 m	1800 mm	Bez potiskivača



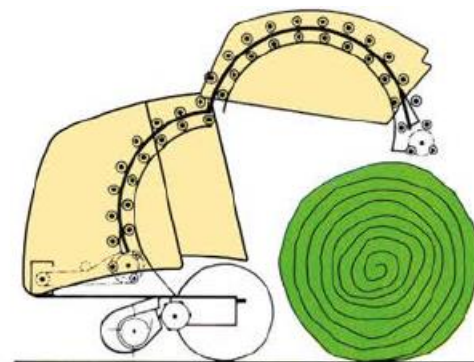
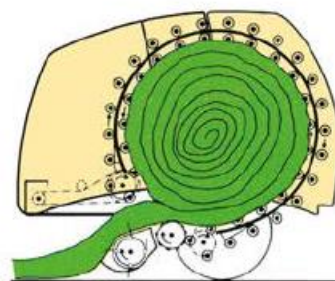
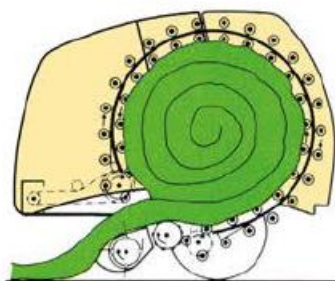
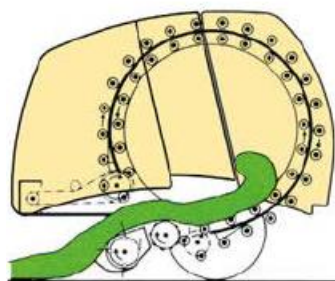
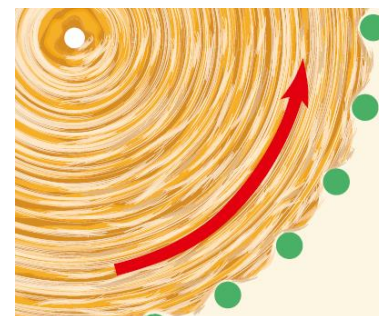



Model	Promjer bala	Uređaj za rezanje
Fortima F 1250	1,25 m	
Fortima F 1250 MC	1,25 m	X
Fortima F 1600	1,55 m	
Fortima F 1600 MC	1,55 m	X

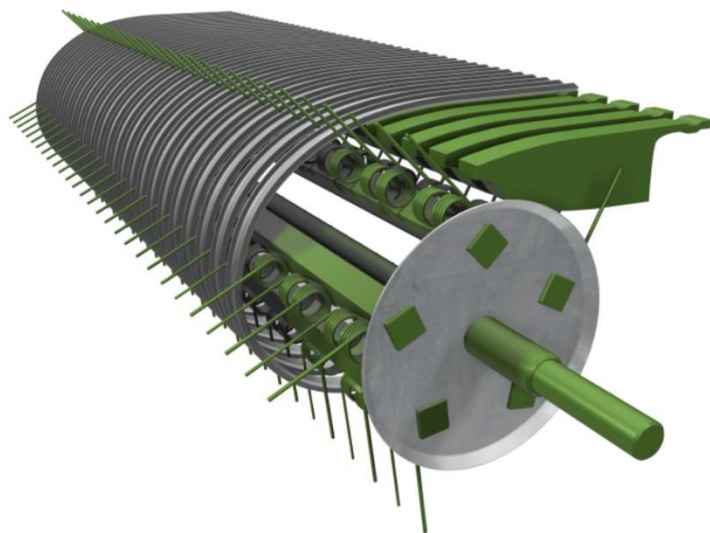

Model	Promjer bala	Uređaj za rezanje
Fortima V 1500	1,00 – 1,50 m	
Fortima V 1500 MC	1,00 – 1,50 m	X
Fortima V 1800	1,00 – 1,80 m	
Fortima V 1800 MC	1,00 – 1,80 m	X



Promjer bala	Fiksna komora	Semi variabilna komora	Variabilna komora
1,25 m	F 125 / F 125 XC		
1,25 m do 1,50 m		F 155 / F 155 XC CF 155 XC	
1,00 m do 1,50 m			V 150 / V 150 XC CV 150 XC
1,00 m do 1,80 m			V 180 / V 180 XC
1,00 m do 2,05 m			V 210 / V 210 XC CV 210 XC



**F 125 / F 125 XC**



**F 155 / F 155 XC**



**CF 155 XC**



**V 150 / V 150 XC  
V 180 / V 180 XC  
V 210 / V 210 XC**



**CV 150 XC  
CV 210 XC**

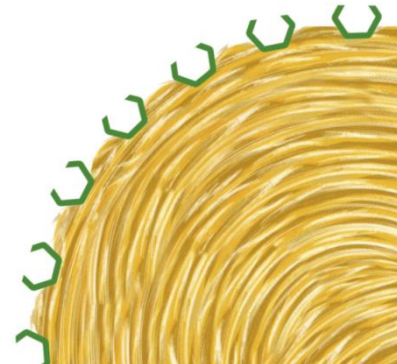

## Comprima X-treme

Model	F 155 XC <i>X-treme</i>	V 150 XC <i>X-treme</i>	CF 155 XC <i>X-treme</i>	CV 150 XC <i>X-treme</i>
Komora	Semi-variabilna	Variabilna	Semi-variabilna	Variabilna
Promjer bale	Ø 1,25 – 1,50 m	Ø 1,00 – 1,50m	Ø 1,25 – 1,50 m	Ø 1,00 – 1,50m



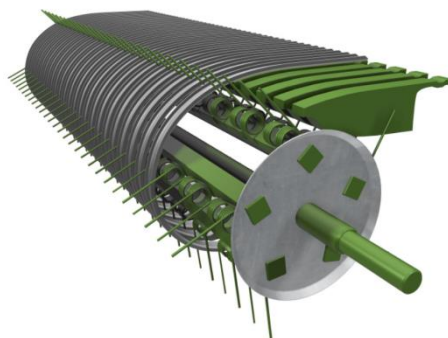
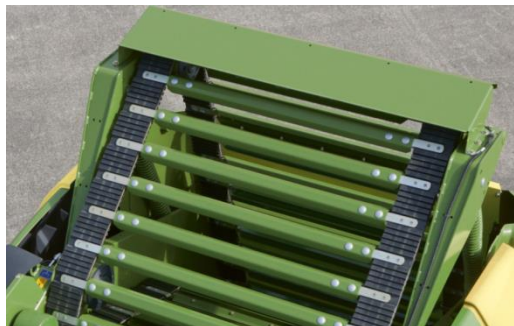

## Ultima CF 155 XC

**NonStop-kombinacija balirke i omotača sa semi-variabilnom komorom**

Širina bale

1,20 m

Promjer bale

1,25 – 1,50 m



		Veličina bale Širina x Visina	Hod čekića u minuti	MultiBale	Uređaj za rezanje PreChop
BiG Pack 870 HDP (XC) Multibale		80 x 70		X	<b>NEU</b>
BiG Pack 890 (XC)		80 x 90	49		
BiG Pack 1270 (XC)		120 x 70	45		X
BiG Pack 1290 (XC)		120 x 90			X
BiG Pack 1290 HDP (XC)					X
BiG Pack 1290 HDP II (XC)					
BiG Pack 4x4 (XC)		120 x 130	38		





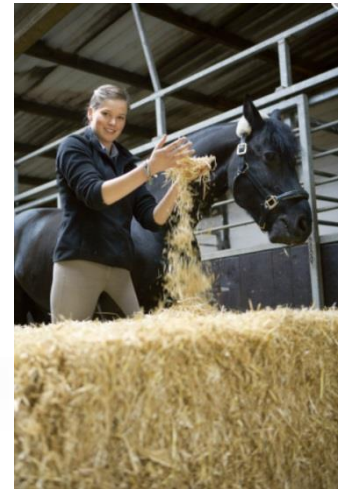

# **KRONE** Samoutovarne prikolice - AX

Volumen  
po DIN



25 m<sup>3</sup>

AX 250 L

AX 250 D

AX 250 GL

AX 250 GD

28 m<sup>3</sup>

AX 280 L

AX 280 GL

AX 280 GD

31 m<sup>3</sup>

AX 310 GL

AX 310 GD



# **KRONE** Samoutovarne prikolice - MX

Volumen po DIN



31 m<sup>3</sup>

MX 320 GL

MX 320 GD

35 m<sup>3</sup>

MX 350 GL

MX 350 GD



**MEHANIZACIJA** Miler<sup>®</sup>

# **KRONE** Samoutovarne prikolice - ZX

Volumen po DIN



39 m<sup>3</sup>

ZX 400 GL

ZX 400 GD

44 m<sup>3</sup>

ZX 450 GL

ZX 450 GD

54 m<sup>3</sup>

ZX 550 GL

ZX 550 GD



# **KRONE** Samoutovarne prikolice

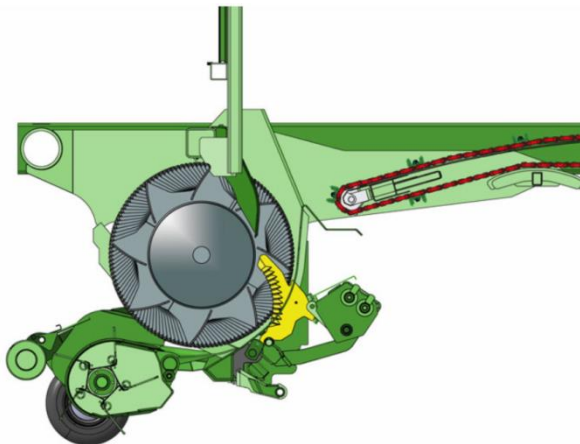

# **KRONE** Nova generacija prikolica ZX

Volumen po DIN



43 m<sup>3</sup>

ZX 430 GL

ZX 430 GD

47 m<sup>3</sup>

ZX 470 GL

ZX 470 GD

56 m<sup>3</sup>

ZX 560 GL

ZX 560 GD



**NEU**

**MEHANIZACIJA** *Miler*<sup>®</sup>

# **KRONE** Nova generacija prikolica ZX

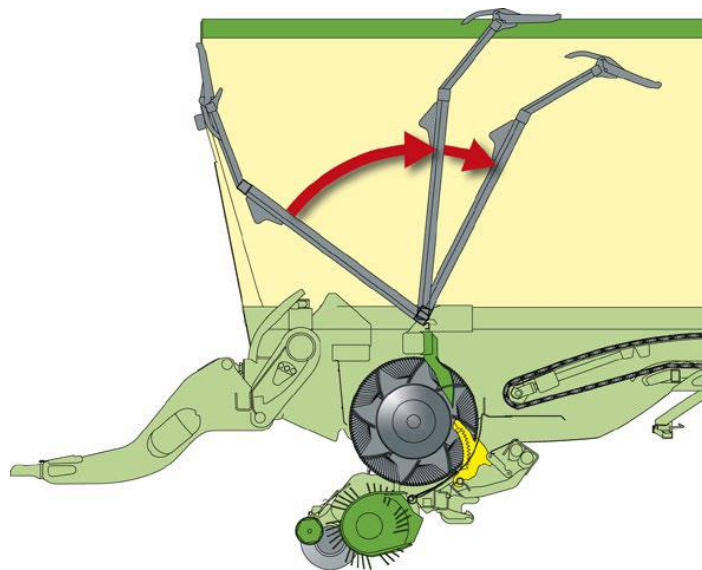
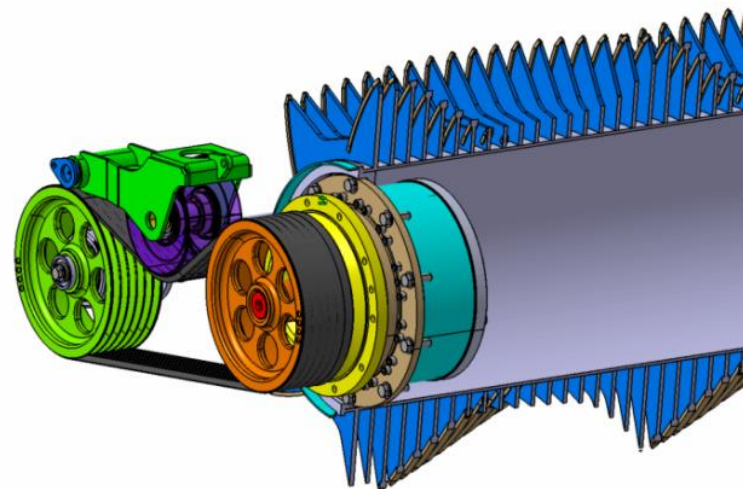
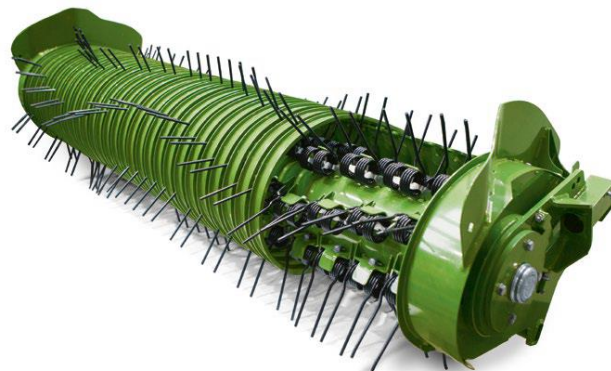

# **KRONE** Transportne prikolice - TX

Volumen po DIN



46 m<sup>3</sup>

TX 460

TX 460 D

56 m<sup>3</sup>

TX 560

TX 560 D





# **KRONE** Transportne prikolice - TX



**Modeli**

BiG X 480

BiG X 530

BiG X 580

BiG X 630



# KRONE BiG X 480-630



VariQuick

StreamControl

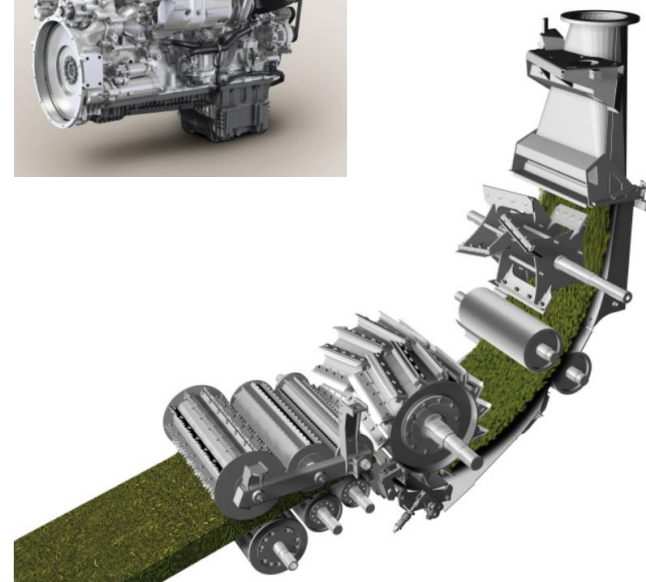
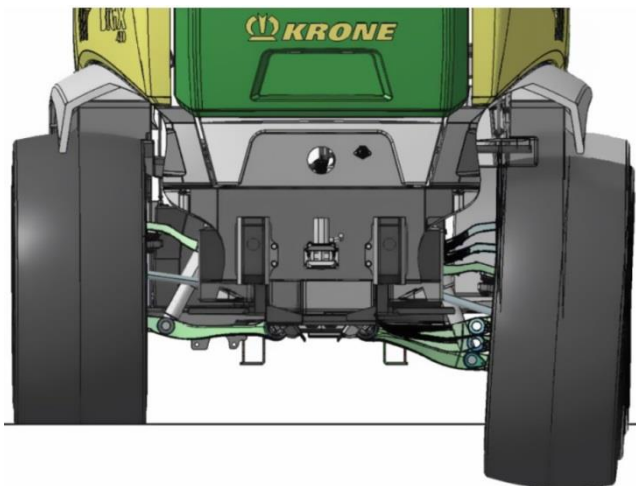

MEHANIZACIJA Miler®



## Modeli

BiG X 600

BiG X 700

BiG X 770

BiG X 850

BiG X 1100

# KRONE BiG X 600-1100



					
Trommeltyp	MaxFlow	MaxFlow	MaxFlow	Biogastrommel	Biogastrommel
Anzahl der Messer pro Trommel	20	28	36	40	48
Schnittlänge	5-29 mm	4-21 mm	3-17 mm	2,5-15 mm	2-12 mm

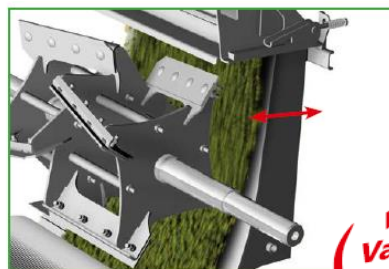
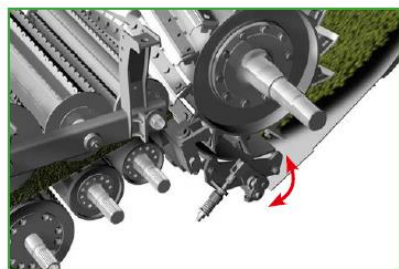
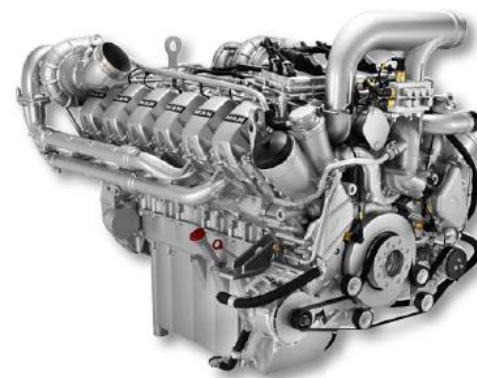

**MEHANIZACIJA Miler®**

**KRONE** Stroj za izradu peleta PREMOS 5000

**NEU**



**MEHANIZACIJA** Miler®



**Innenliegende Förderschnecken**  
Förderung der Pellets aus den  
Matrizenwalzen zum Förderband

**Siebtrommel**  
Entstaubung und Absiebung.  
Material fällt nach unten auf das  
Zuführband (Überkehrprinzip)

**Förderband**

**Förderrotor**  
800 mm Breite  
Kein Schneidwerk!

**Zahnpackerwalze**  
Gleichmäßige und kontrollierte  
Futteraufnahme der Pick-up

**Pick-up**  
(ungesteuert)

**Zuführband / Zuführkanal**  
800 mm Breite

**2 Matrizen-Walzen**  
je 800 mm Breite  
je 800 mm Durchmesser

**Förderband**

**Pellet-Bunker**  
9.000 Liter  
ca. 5.000 kg

